

# BP2100G1 Tech Sheet

**Customer:** Balboa Water Group

**Part Number:** 56389-01 800 Incoloy  
56390-01 8250 Incoloy  
56391-01 Titanium

Custom Box Overlay   
Box Overlay Part Number N/A

UL System Model: BP21-BP2100G1-RCA3.0K  
Software Version ID: M100\_225 V13.0  
Software Version: 13.0  
File Name: BP2100\_13.0\_BP2100G1\_18.hex  
Configuration Signature: EBCE9FD8

Eng. Project Number: 4008

Base PCBA: 56392-01  
Bare Board: 24082\_E

## Control Panels:

TP600CE version 2.3 or later 50336 with Overlay  
50015 without Overlay

TP600 (non-CE) should not be used.

TP800 version 1.2 or later 50261 with Overlay  
50204 without Overlay

TP900 version 1.2 or later 50262 with Overlay  
55994 without Overlay



Manufactured under one or more of these patents. U.S. Patents: 5332944, 5361215, 5550753, 5559720, 5,883,459, 6253227, 6282370, 6590188, 6976052, 6965815, 7030343, 7,417,834 b2, Canadian Patent: 2342614, Australian patent: 2373248 other patents both foreign and domestic applied for and pending. © Copyright 2012 Balboa Water Group.

# System Revision History

Part #	EPN	Date	Originator	Changes Made
56389 56390 56391	3936	12-07-12	BWG	Initial Release BP2100G1
56389-01 56390-01 56391-01	4008	01-31-13	BWG	Add Setup 18. Add TP600 support.

Manufactured under one or more of these patents. U.S. Patents: 5332944, 5361215, 5550753, 5559720, 5,883,459, 6253227, 6282370, 6590188, 6976052, 6965815, 7030343, 7,417,834 b2, Canadian Patent: 2342614, Australian patent: 2373248 other patents both foreign and domestic applied for and pending. © Copyright 2012 Balboa Water Group.



# Basic Functions Setup 1-18

---

## Power Requirements:

**Single Service** [3 wires (line, neutral, ground)]

230VAC, 50Hz, 1p, 32A, (Circuit Breaker rating = 40A max.)

**Dual Service** N/A

**3-Service** [5 wires (line 1, line 2, line 3, neutral, ground)]

400VAC, 50Hz, 3p, 16A, (Circuit Breaker rating = 20A max each phase line.)

**IMPORTANT** - Service must include a neutral wire, with a line to neutral voltage of 230VAC.

---

# Basic Functions Setup 1-18

---

## System Outputs:

Pump 1	230VAC	2-Speed 1-Speed in Setups 12, 14, 17	12A max	15-minute timer for High Speed, 15-Minute timer for Low Speed
		This is the heater pump in Setups 1-6, 15, 18 Must deliver 20 GPM through heater		
Pump 2	230VAC	2-Speed 1-Speed in Setups 5, 6, 11-14, 17, 18	12A max	15-minute timer
Pump 3	230VAC	2-Speed 2-Speed in Setups 1, 7 1-Speed in Setups 2, 5, 6, 8, 11-16 Unused in Setups 3, 4, 9, 10, 17, 18	12A max	15-minute timer
Blower	230VAC	1 Speed Unused in Setups 1, 2, 4, 6-8, 10, 13, 14	4A max	15-minute timer
Circ Pump	230VAC	1-Speed This is the heater pump in Setups 7-14, 16, 17 Must deliver 20 GPM through heater	2A max	Programmable Filtration Cycles + Polling
Ozone	230VAC		.5A max	Slaved to Circ Pump in Setups 7-14, 16, 17 Independent in Setups 1-6, 15, 18
Spa Light	10VAC	On/Off	1A max	240-minute timer.
A/V (Stereo)	230VAC	Hot	5A max	Always on
Heater	3.0kW @ 240VAC max			

# Hardware Setup

## Wiring Diagram

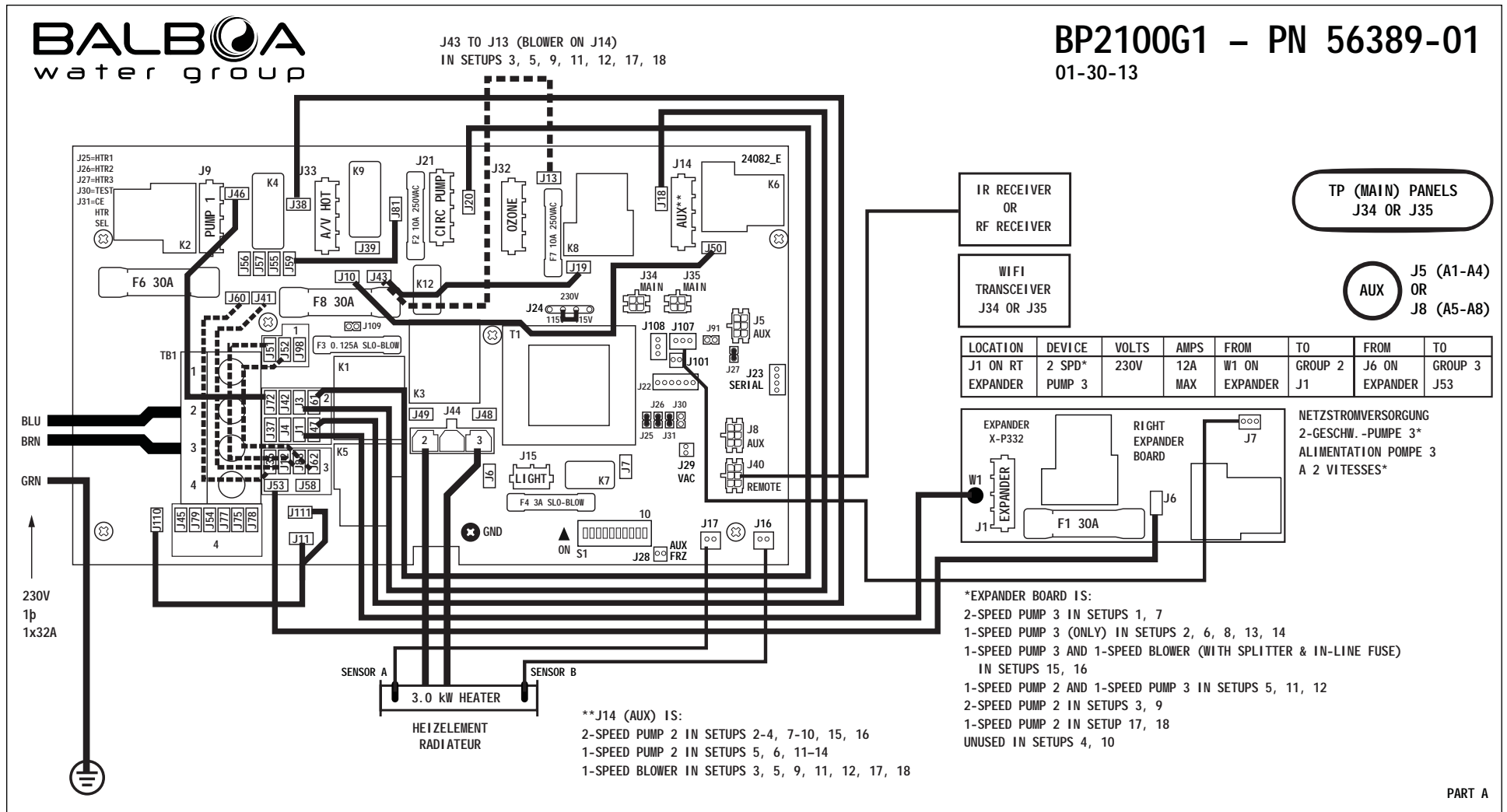

Manufactured under one or more of these patents. U.S. Patents: 5332944, 5361215, 5550753, 5559720, 5,883,459, 6253227, 6282370, 6590188, 6976052, 6965815, 7030343, 7,417,834 b2, Canadian Patent: 2342614, Australian patent: 2373248 other patents both foreign and domestic applied for and pending.

© Copyright 2012 Balboa Water Group.

**BALBOA**  
water group

# Hardware Setup

## Settings

SINGLE SERVICE 230V 1p / 1x32A, THREE-SERVICE 230V 1p / 3x16A

LOCATION	DEVICE
J9	NETZSTROMVERSORGUNG 2-GESCHW.-PUMPE 1 ALIMENTATION POMPE 1 A 2 VITESSES 2-SPEED PUMP 1
J14	AUX**
	AUX LINE 1 CONNECTION J19 to J43
J15	10V BELEUCHTUNG ECLAIRAGE BAIN HYDRO SPA LIGHT
J21	KREISLAUF PUMPE POMPE DE CIRCULATION CIRC PUMP (SETUPS 7-14, 16)
J32	OZONGENERATOR GENERATOROZONE OZONE GENERATOR
	CIRC AND OZONE LINE 1 CONNECTION J81 to J59
J33	TV / AV
J40	IR RECEIVER
J5, J8	AUX PANEL(S) - AX10, AX20, AX30, AX40

SETUP #	CIRC PUMP	PUMP 1	PUMP 2	PUMP 3	BLOWER	TEMP SCALE
1	NONE	2-SPEED	2-SPEED	2-SPEED	NONE	°C
2	NONE	2-SPEED	2-SPEED	1-SPEED	NONE	°C
3	NONE	2-SPEED	2-SPEED	NONE	1-SPEED	°C
4	NONE	2-SPEED	2-SPEED	NONE	NONE	°C
5†	NONE	2-SPEED	1-SPEED	1-SPEED	1-SPEED	°C
6	NONE	2-SPEED	1-SPEED	1-SPEED	NONE	°C
7	PROGRAMMABLE FILTRATION + POLLING	2-SPEED	2-SPEED	2-SPEED	NONE	°C
8	PROGRAMMABLE FILTRATION + POLLING	2-SPEED	2-SPEED	1-SPEED	NONE	°C
9	PROGRAMMABLE FILTRATION + POLLING	2-SPEED	2-SPEED	NONE	1-SPEED	°C
10	PROGRAMMABLE FILTRATION + POLLING	2-SPEED	2-SPEED	NONE	NONE	°C
11‡	PROGRAMMABLE FILTRATION + POLLING	2-SPEED	1-SPEED	1-SPEED	1-SPEED	°C
12‡	PROGRAMMABLE FILTRATION + POLLING	1-SPEED	1-SPEED	1-SPEED	1-SPEED	°C
13	PROGRAMMABLE FILTRATION + POLLING	2-SPEED	1-SPEED	1-SPEED	NONE	°C
14	PROGRAMMABLE FILTRATION + POLLING	1-SPEED	1-SPEED	1-SPEED	NONE	°C
15‡***	NONE	2-SPEED	2-SPEED	1-SPEED	1-SPEED	°C
16‡***	PROGRAMMABLE FILTRATION + POLLING	2-SPEED	2-SPEED	1-SPEED	1-SPEED	°C
17	PROGRAMMABLE FILTRATION + POLLING	1-SPEED	1-SPEED	NONE	1-SPEED	°C
18	NONE	2-SPEED	1-SPEED	NONE	1-SPEED	°C

PUMP 1 LOW TIMEOUT IS 15 MINUTES.

†SETUPS 5, 11, 12, 15 AND 16 REQUIRE BP2X-WIRE KIT PN30893

\*\*\*SETUPS 15 AND 16 REQUIRE ADDITIONAL FUSED ADAPTER FOR BLOWER OUTPUT

INSTEAD OF  
SETUP #1,  
THIS SYSTEM IS  
CONFIGURED IN  
SETUP #:

FOR SUPPLY CONNECTIONS,  
USE CONDUCTORS SIZED ON THE  
BASIS OF 60°C AMPACITY BUT  
RATED MINIMUM OF 90°C.

USE COPPER CONDUCTORS ONLY.  
EMPLOYER UNIQUEMENT  
DES CONDUCTEURS DE CUIVRE.

TORQUE RANGE FOR  
MAIN TERMINAL BLOCK (TB1):  
27-30 IN. LBS.  
(31.1-34.5 kg cm)

**BALBOA**  
water group

**BP2100G1 - PN 56389-01**  
01-30-13

PART B

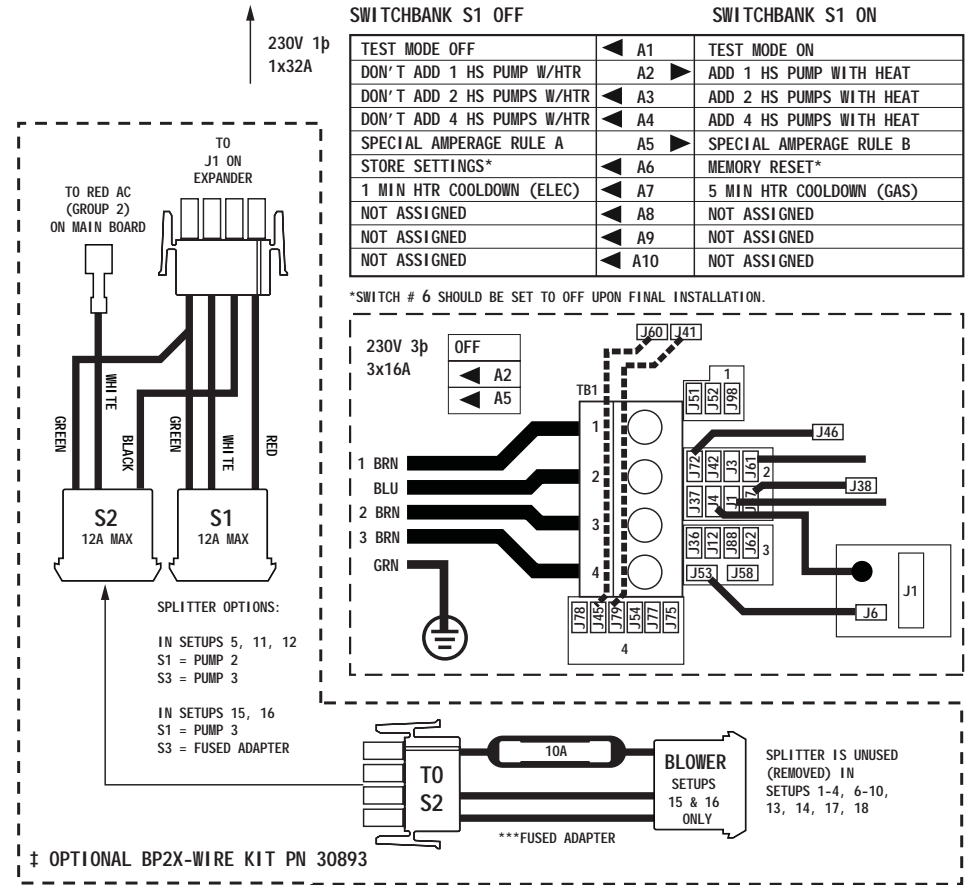

# Setup Reference Table

Setup #	Circ Pump	Pump 1	Pump 2	Pump 3	Blower	Temp Scale
1	None	2-Speed	2-Speed	2-Speed	None	°C
2	None	2-Speed	2-Speed	1-Speed	None	°C
3	None	2-Speed	2-Speed	None	1-Speed	°C
4	None	2-Speed	2-Speed	None	None	°C
5	None	2-Speed	1-Speed	1-Speed	1-Speed	°C
6	None	2-Speed	1-Speed	1-Speed	None	°C
7	Programmable Filtration + Polling	2-Speed	2-Speed	2-Speed	None	°C
8	Programmable Filtration + Polling	2-Speed	2-Speed	1-Speed	None	°C
9	Programmable Filtration + Polling	2-Speed	2-Speed	None	1-Speed	°C
10	Programmable Filtration + Polling	2-Speed	2-Speed	None	None	°C
11	Programmable Filtration + Polling	2-Speed	1-Speed	1-Speed	1-Speed	°C
12	Programmable Filtration + Polling	1-Speed	1-Speed	1-Speed	1-Speed	°C
13	Programmable Filtration + Polling	2-Speed	1-Speed	1-Speed	None	°C
14	Programmable Filtration + Polling	1-Speed	1-Speed	1-Speed	None	°C
15	None	2-Speed	2-Speed	1-Speed	1-Speed	°C
16	Programmable Filtration + Polling	2-Speed	2-Speed	1-Speed	1-Speed	°C
17	Programmable Filtration + Polling	1-Speed	1-Speed	None	1-Speed	°C
18	None	2-Speed	1-Speed	None	1-Speed	°C

**System is shipped in Setup 1**

Pump 1 Low timeout is 15 minutes.

Color Key	Output
	XP332
	XP332 and Splitter
	XP332 and Splitter and in-line Blower fuse
	J14 (Aux) on Main Board

# Changing Software Setups

## Test Menu Access (S1, Switch 1 ON) *Service Technician ONLY.*

**DANGER! HIGH VOLTAGE WILL BE ACCESSIBLE! SERVICE TECHNICIAN ONLY!**

While the system is running, move DIP Switch 1 (on S1 on the Main circuit board) to ON. The system will enter Test Mode. Moving DIP Switch 1 to OFF will exit Test Mode.

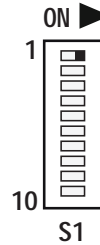

## Software Setups

Under the TEST Menu, the Setup screen will allow changing the Setup from 1 to any number established by the Manufacturer. Changing the Setup may require wiring changes as well.

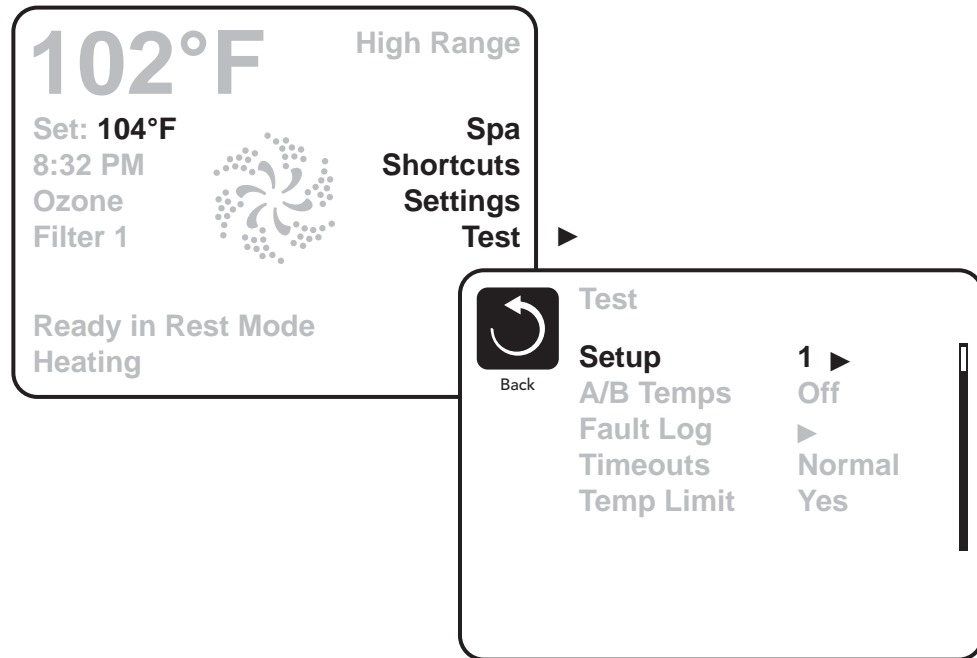



# Equipment Expansion

---

## Expansion Features

### Control Connection

	<b>Default</b>	<b>Fuse</b>
Relay 1 (J101)	Undefined	None
Relay 7/8 (J107)	See Below	30A
	2-Speed Pump 3 In Setups 1, 7	
	1-Speed Pump 3 (only) In Setups 2, 6, 8, 13, 14	
	1-Speed Pump 3 And 1-Speed Blower (With Splitter & In-Line Fuse) In Setups 15, 16	
	1-Speed Pump 2 And 1-Speed Pump 3 In Setups 5, 11, 12	
	2-Speed Pump 2 In Setups 3, 9	
	1-Speed Pump 2 In Setup 17, 18	
	Unused In Setups 4, 10	
Relay 9/10 (J108)	Undefined	None

# DIP Switch Functions

## Fixed-function DIP Switches

- |    |  |
|----|--|
| A1 | Test Mode (normally Off).  |
| A2 | In "ON" position, add one high-speed pump (or blower) with Heater.   |
| A3 | In "ON" position, add two high-speed pumps (or 1 HS Pump and Blower) with Heater.  |
| A4 | In "ON" position, add four high-speed pumps (or 3 HS Pumps and Blower) with Heater.  |
| A5 | In "ON" position, enables Special Amperage Rule B. See Special Features section under Configuration Options for functionality with your system.<br>In "OFF" position, enables Special Amperage Rule A. |
| A6 | Persistent memory reset (Used when the spa is powering up to restore factory settings as determined by software configuration).  |

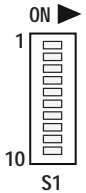

**A2, A3, and A4** work in combination to determine the number of high-speed devices and blowers that can run before the heat is disabled. i.e. A2 and A3 in the ON position and A4 in the OFF position will allow the heater to operate with up to 3 high-speed pumps (or two HS Pumps and Blower) running at the same time. Heat is disabled when the fourth high-speed pump or blower is turned on.







**Note:** A2/A3/A4 all off = No heat with any high-speed pump or blower.

## Assignable DIP Switches

- |    |   |
|----|---|
| A7 | In "ON" position, enables a 5-minute cooldown for some gas heaters (Cooling Time B).<br>In "OFF" position, enables a 1-minute cooldown for electric heaters (Cooling Time A). |
|----|---|

*Undesignated switches are not assigned a function.*

# Jumper Definitions

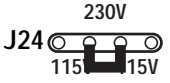
<b>J109</b>	Non Applicable on CE models	J109 
<b>J91</b>	Real Time Clock Enable/Disable <b>Note:</b> This Jumper should NOT be shorted when the Control Panel can display time of day.	J91 
<b>J30</b>	Do Not Use	
<b>J31</b>	Jumper on 1 pin with 2.0kW or smaller heater Jumper on 2 pins with a 3.0kW or higher heater	J31 
<b>J29</b>	Do Not Use	J29 
<b>J25, J26, J27</b>	Heater Type Settings. <b>Note:</b> Factory Configured do not change.	J25  J26  J27 
<b>J24</b>	Jumper on center two pins (230V) when heater is running at 240V. Two Jumpers installed; one on left 2 pins and one on right 2 pins (115V) when heater is running at 120V.	J24 

## Warning!

Setting DIP switches or jumpers incorrectly may cause abnormal system behavior and/or damage to system components. Refer to Switchbank illustration on Wiring Configuration page for correct settings for this system. Contact Balboa if you require additional configuration pages added to this tech sheet.

# BP2000 Configuration Options

---

## General Features

Feature	Default
Pump 1 in Filter Cycle (Circ Only)	No
Pump 1 Low Timer	<i>15 Minutes</i>
General Pump Timer	15 Minutes
Blower Timer	15 Minutes
Mister Timer	15 Minutes
Light Timer	240 Minutes
Circ (when enabled)	Programmable + Polling
Cleanup Cycle	<i>30 Minutes</i>
Cleanup as Preference setting	<i>Yes</i>
Ozone	With Heater Pump*
Ozone Suppression	OFF
Pump Purge	60 Seconds
Blower Purge	30 Seconds
Mister Purge	5 Seconds

\* The heater Pump can be either a Circ Pump or Pump 1 Low.

*Blue Indicates New Custom Configuration Default (Setup 1)*

Manufactured under one or more of these patents. U.S. Patents: 5332944, 5361215, 5550753, 5559720, 5,883,459, 6253227, 6282370, 6590188, 6976052, 6965815, 7030343, 7,417,834 b2, Canadian Patent: 2342614, Australian patent: 2373248 other patents both foreign and domestic applied for and pending. © Copyright 2012 Balboa Water Group.

# BP2000 Configuration Options

## Temperature Features

Feature	Default
Temperature Display	°C

All temperatures must be specified in °F. The system converts °F to °C dynamically. If Celsius is required for default settings, choose a desired °C value that (after rounding) corresponds to a Fahrenheit value.

°C	4	5	6	7	8	9	10	11	12	13	14	15	16	17	18	19	20	21	22
°F	39	41	43	45	46	48	50	52	54	55	57	59	61	63	64	66	68	70	72
°C	23	24	25	26	27	28	29	30	31	32	33	34	35	36	37	38	39	40	
°F	73	75	77	79	81	82	84	86	88	90	91	93	95	97	99	100	102	104	

Hi-Range Min. Set Temp	80°F
Hi-Range Max. Set Temp	104°F
Hi-Range Default Temp*	100°F
Lo-Range Min. Set Temp	50°F
Lo-Range Max. Set Temp	99°F
Lo-Range Default Temp*	70°F
Freeze Threshold	44°F
Temp Lock Type	Temp + Settings

\*May be changed by end-user (if enabled)

Blue Indicates New Custom Configuration Default (Setup 1)

Manufactured under one or more of these patents. U.S. Patents: 5332944, 5361215, 5550753, 5559720, 5,883,459, 6253227, 6282370, 6590188, 6976052, 6965815, 7030343, 7,417,834 b2, Canadian Patent: 2342614, Australian patent: 2373248 other patents both foreign and domestic applied for and pending. © Copyright 2012 Balboa Water Group.

# BP2000 Configuration Options

---

## Time Features

<b>Feature</b>	<b>Default</b>
Time Format*	24 Hour
Filter 1 Start Hour*	20:00 (8:00 PM)
Filter 1 Duration*	2 Hours
Filter Cycle 2 Default*	OFF
Filter 2 Start Hour*	08:00 (8:00 AM)
Filter 2 Duration*	15 Minutes
Light Cycle	Disabled
Light Cycle Default*	OFF
Light Cycle Start Hour*	21:00 (9:00 PM)
Light Cycle Duration*	15 Minutes
Cooling Time A	1 Minute
Cooling Time B	5 Minutes

*\*May be changed by end-user (if enabled)*

*Blue Indicates New Custom Configuration Default (Setup 1)*

Manufactured under one or more of these patents. U.S. Patents: 5332944, 5361215, 5550753, 5559720, 5,883,459, 6253227, 6282370, 6590188, 6976052, 6965815, 7030343, 7,417,834 b2, Canadian Patent: 2342614, Australian patent: 2373248 other patents both foreign and domestic applied for and pending. © Copyright 2012 Balboa Water Group.

# BP2000 Configuration Options

---

## Reminder Features

Feature	Default
Reminders Shown*	<i>Yes</i>
Check pH	<i>OFF</i>
Check Sanitizer	<i>OFF</i>
Clean Filter	30 Days
Test GFCI	<i>65 Days</i>
Drain Water	<i>100 Days</i>
Change Cartridge	OFF
Clean Cover	<i>OFF</i>
Treat Wood	<i>OFF</i>
Change Filter	365 Days

*\*May be changed by end-user (if enabled)*

*Blue Indicates New Custom Configuration Default (Setup 1)*

Manufactured under one or more of these patents. U.S. Patents: 5332944, 5361215, 5550753, 5559720, 5,883,459, 6253227, 6282370, 6590188, 6976052, 6965815, 7030343, 7,417,834 b2, Canadian Patent: 2342614, Australian patent: 2373248 other patents both foreign and domestic applied for and pending. © Copyright 2012 Balboa Water Group.

# BP2000 Configuration Options

---

## Special Features

Feature	Default
Special Amperage Rule A	No Limitation
Special Amperage Rule B	2 high-speed pumps max. Blower turns off with 2 high speed pumps - in Setups 1-4, 6-10, 13, 15, 16, 18 No Limitation - in Setups 5, 11, 12, 14, 17
Drain Mode	Disabled
Demo Mode	Disabled
Automatic GFCI Test	Disabled
Ozone Slaved to Heater Pump	<i>Yes in circ setups</i> <i>No in non-circ setups</i>
Dual Voltage Heater	Always Input Voltage
Safety Suction	Disabled



# TP600 Panel Configuration

**Button Layout Table**

Button #	Pump 3 or Pump 3 + Blower*	No Pump 3, Blower	No Pump 3, No Blower
	Setups 1, 2, 5, 6, 7, 8, 11, 12, 13, 14, 15, 16	Setup 3, 9, 17, 18	Setup 4, 10
1	Jets 1	Jets 1	Jets 1
2	Jets 2	Jets 2	Jets 2
3	Jets 3	Blower	Unused
4	Up	Up	Up
5	Light 1	Light 1	Light 1
6	Down	Down	Down
LED 1	Jets 1	Jets 1	Jets 1
LED 2	Jets 2	Jets 2	Jets 2
LED 3	Light 1	Light 1	Light 1
LED 4	Heat On	Heat On	Heat On

\* When using setups in column 1, which operate both a Pump 3 AND a Blower, Pump 3 is on the main panel (Button 3) and Blower must be operated with an Auxilliary Panel - AX10A3 on Bank 1 (J5).

See Page 21.

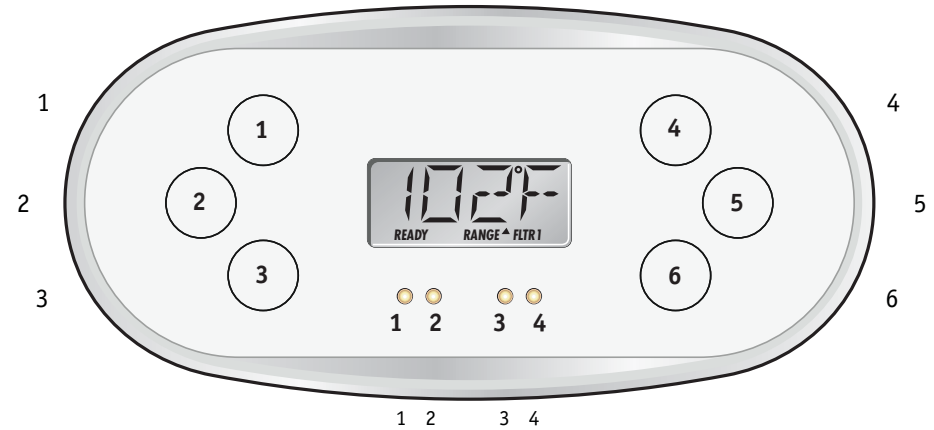

## TP600CE

50015 - No Overlay

50336 - Includes Overlay PN 12762

TP600 (non-CE) should not be used.



# TP800 Panel Configuration

## Button Layout Table

Feature #	Pump 3, Blower & Circ Setups 11, 12, 16	NO Pump 3, Blower & Circ Setups 9, 17	Pump 3, NO Blower & Circ Setups 7, 8, 13, 14	NO Pump 3, NO Blower & Circ Setup 10	Pump 3, Blower & NO Circ Setups 5, 15	NO Pump 3, Blower & NO Circ Setup 3	Pump 3, NO Bl & NO Circ Setups 1, 2, 6	NO Pump 3, NO Bl & NO Circ Setup 4
A1	N/A	N/A	N/A	N/A	N/A	N/A	N/A	N/A
A2	Jets 1	Jets 1	Jets 1	Jets 1	Jets 1	Jets 1	Jets 1	Jets 1
A3	Jets 2	Jets 2	Jets 2	Jets 2	Jets 2	Jets 2	Jets 2	Jets 2
A4	Jets 3	Blower	Jets 3	Light 1	Jets 3	Blower	Jets 3	Light 1
A5	Blower	Light 1	Light 1	Invert	Blower	Light 1	Light 1	Invert
A6	Light 1	Invert	Invert	(Circ Icon)	Light 1	Invert	Invert	Undefined
A7	Invert	(Circ Icon)	(Circ Icon)	Undefined	Invert	Undefined	Undefined	Undefined
A8	(Circ Icon)	Undefined	Undefined	Undefined	Undefined	Undefined	Undefined	Undefined
A9	Undefined	Undefined	Undefined	Undefined	Undefined	Undefined	Undefined	Undefined
A10	Undefined	Undefined	Undefined	Undefined	Undefined	Undefined	Undefined	Undefined
A11	N/A	N/A	N/A	N/A	N/A	N/A	N/A	N/A
A12	N/A	N/A	N/A	N/A	N/A	N/A	N/A	N/A
A13	Jets 1	Jets 1	Jets 1	Jets 1	Jets 1	Jets 1	Jets 1	Jets 1
A14	Jets 2	Jets 2	Jets 2	Jets 2	Jets 2	Jets 2	Jets 2	Jets 2
A15	Blower	Blower	Jets 3	Light	Blower	Blower	Jets 3	Light
A16	Light	Light	Light	Invert	Light	Light	Light	Invert
B1	Jets 1	Jets 1	Jets 1	Jets 1	Jets 1	Jets 1	Jets 1	Jets 1
B2	Jets 2	Jets 2	Jets 2	Jets 2	Jets 2	Jets 2	Jets 2	Jets 2
B3	Jets 3	Blower	Jets 3	Undefined	Jets 3	Blower	Jets 3	Undefined
B4	Light 1	Light 1	Light 1	Light 1	Light 1	Light 1	Light 1	Light 1

# TP800 Panel Configuration

## Spa Screen

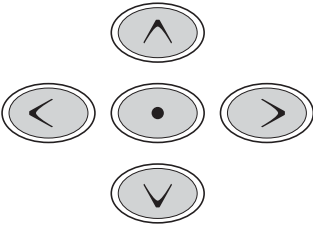
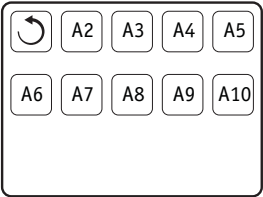
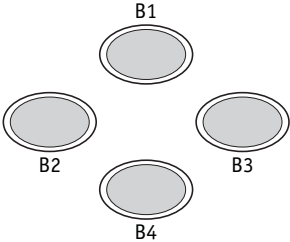

## Shortcuts Screen

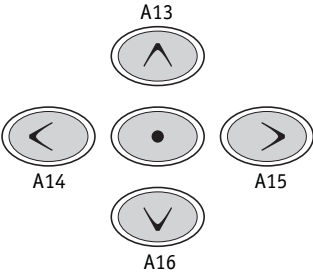
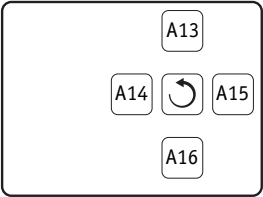
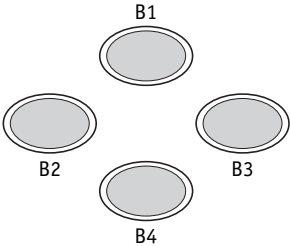

**Note:** Buttons 11 and 12 are not used in this configuration.  
Button 1 is fixed.

Panel Part Number \_\_\_\_\_

Overlay Part Number \_\_\_\_\_

*A Circ Icon will appear when a Circ Pump is configured using Setups 3, 4, 8, 9*

# TP900 Panel Configuration

## Button Layout Table

Button #	Pump 3, Blower & Circ Setups 11, 12, 16	NO Pump 3, Blower & Circ Setups 9, 17	Pump 3, NO Blower & Circ Setups 7, 8, 13, 14	NO Pump 3, NO Blower & Circ Setup 10	Pump 3, Blower & NO Circ Setups 5, 15	NO Pump 3, Blower & NO Circ Setup 3	Pump 3, NO Bl & NO Circ Setups 1, 2, 6	NO Pump 3, NO Bl & NO Circ Setup 4
1	N/A	N/A	N/A	N/A	N/A	N/A	N/A	N/A
2	Jets 1	Jets 1	Jets 1	Jets 1	Jets 1	Jets 1	Jets 1	Jets 1
3	Jets 2	Jets 2	Jets 2	Jets 2	Jets 2	Jets 2	Jets 2	Jets 2
4	Jets 3	Blower	Jets 3	Light 1	Jets 3	Blower	Jets 3	Light 1
5	Blower	Light 1	Light 1	Invert	Blower	Light 1	Light 1	Invert
6	Light 1	Invert	Invert	(Circ Icon)	Light 1	Invert	Invert	Undefined
7	Invert	(Circ Icon)	(Circ Icon)	Undefined	Invert	Undefined	Undefined	Undefined
8	(Circ Icon)	Undefined	Undefined	Undefined	Undefined	Undefined	Undefined	Undefined
9	Undefined	Undefined	Undefined	Undefined	Undefined	Undefined	Undefined	Undefined
10	Undefined	Undefined	Undefined	Undefined	Undefined	Undefined	Undefined	Undefined
11	N/A	N/A	N/A	N/A	N/A	N/A	N/A	N/A
12	N/A	N/A	N/A	N/A	N/A	N/A	N/A	N/A
13	Jets 1	Jets 1	Jets 1	Jets 1	Jets 1	Jets 1	Jets 1	Jets 1
14	Jets 2	Jets 2	Jets 2	Jets 2	Jets 2	Jets 2	Jets 2	Jets 2
15	Jets 3	Blower	Jets 3	Light	Jets 3	Blower	Jets 3	Light
16	Light	Light	Light	Invert	Light	Light	Light	Invert

A Circ Icon will appear when a Circ Pump is configured.

# TP900 Panel Configuration

Button #
1
2
3
4
5
6
7
8
9
10
11
12
13
14
15
16

## Spa Screen

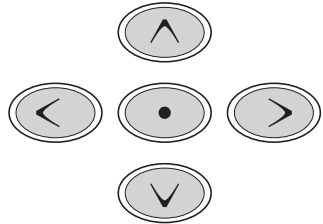
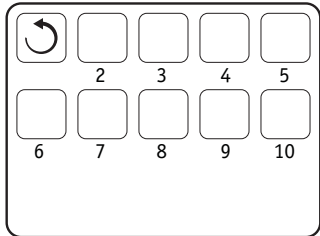

## Shortcuts Screen

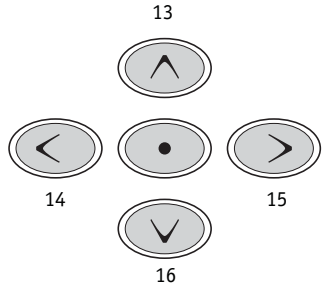
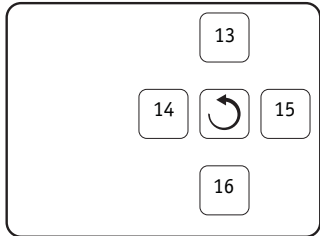

Manufactured under one or more of these patents. U.S. Patents: 5332944, 5361215, 5550753, 5559720, 5,883,459, 6253227, 6282370, 6590188, 6976052, 6965815, 7030343, 7,417,834 b2, Canadian Patent: 2342614, Australian patent: 2373248 other patents both foreign and domestic applied for and pending. © Copyright 2012 Balboa Water Group.



# BP2000 Configuration Options

---

## Auxilliary Panel Features on Bank 1\*

Feature	Default
Aux Button A1	Jets 1
Aux Button A2	Jets 2
Aux Button A3	Blower
Aux Button A4	Light

## Auxilliary Panel Features on Bank 2\*

Feature	Default
Aux Button A5	Jets 1
Aux Button A6	Jets 2
Aux Button A7	Jets 3
Aux Button A8	Light

\*Bank 1 consists of J5 on the Main Circuit Board.  
Bank 2 consists of J8 on the Main Circuit Board.  
**Aux Connection Splitter PN25257 may be required.**

# BP2000 Configuration Options

## Auxilliary Panel Features

### AX10 Panels on Bank 1\*

A1, AX10A1	No O/L	52803	
A2, AX10A2	No O/L	52804	
A3, AX10A3	No O/L	55805	▶
A4, AX10A4	No O/L	52806	

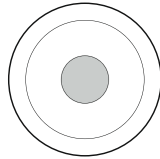

Call Customer Service for additional information about Auxiliary Panels.

Auxiliary Panel Part Number \_\_\_\_\_

Overlay Part Number \_\_\_\_\_

### AX10 Panels on Bank 2\*

A5, AX10A1	No O/L	52803
A6, AX10A2	No O/L	52804
A7, AX10A3	No O/L	52805
A8, AX10A4	No O/L	52806

\*Bank 1 consists of J5 on the Main Circuit Board.

Bank 2 consists of J8 on the Main Circuit Board.

**Aux Connection Splitter PN25257 may be required.**

### AX20

AX20 A1A2	No O/L	52800
AX20 A1A3	No O/L	52801
AX20 A1A4	No O/L	52802

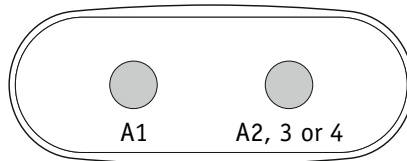

**AX20 Auxiliary Panel plugged into Bank 1 will operate A1 + A2, A3 or A4.**

**AX20 Auxiliary Panel plugged into Bank 2 will operate A5 + A6, A7 or A8.**

### AX40

AX40	No O/L	52799
------	--------	-------

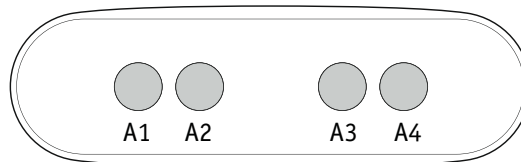

**AX40 Auxiliary Panel plugged into Bank 1 will operate A1 + A2, A3 and A4.**

**AX40 Auxiliary Panel plugged into Bank 2 will operate A5 + A6, A7 and A8.**

# BP2000 Configuration Options

## Remote Panel Features

Feature	Default
Remote Button A1	Jets 1
Remote Button A2	Jets 2
Remote Button A3	Jets 3
Remote Button A4	Blower
Remote Button A5	Light
Remote Button A6	Undefined
Remote Button A7	Undefined
Remote Button A8	Undefined

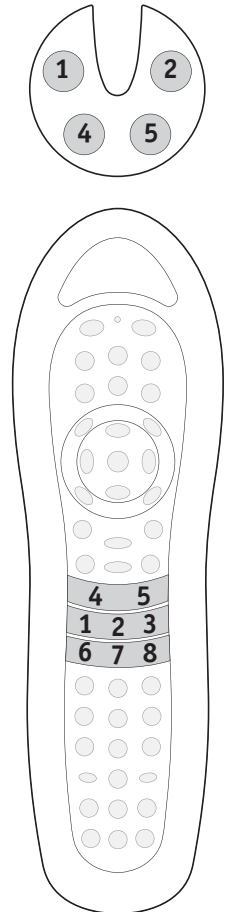

Remote Panel Part Number \_\_\_\_\_  
 Overlay Part Number \_\_\_\_\_

Manufactured under one or more of these patents. U.S. Patents: 5332944, 5361215, 5550753, 5559720, 5,883,459, 6253227, 6282370, 6590188, 6976052, 6965815, 7030343, 7,417,834 b2, Canadian Patent: 2342614, Australian patent: 2373248 other patents both foreign and domestic applied for and pending. © Copyright 2012 Balboa Water Group.